

PROMOTIONS 2024

NEOLOGIQ
MACHINING INTELLIGENTLY

ISCAR METALS

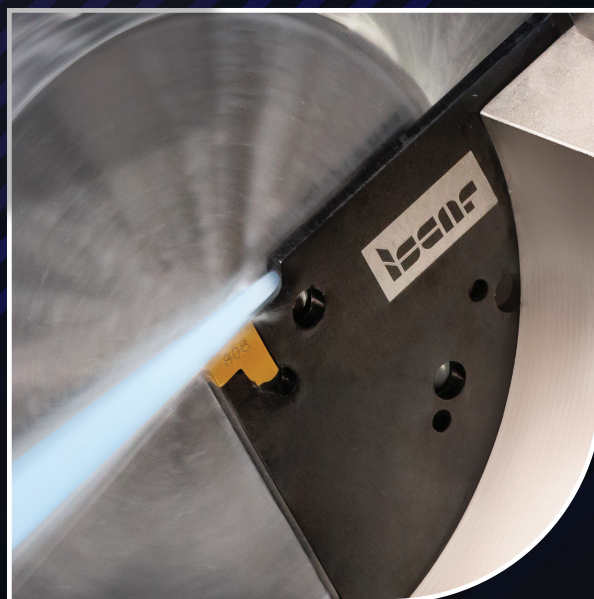
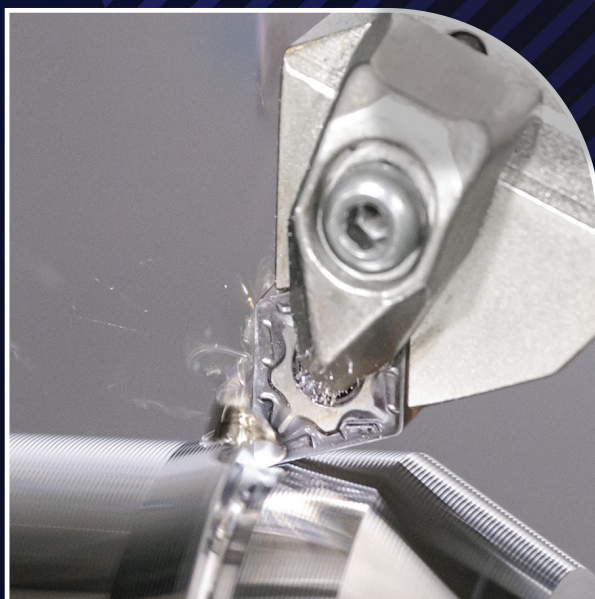

MACHINING INTELLIGENTLY

Member IMC Group
iscar
www.iscar.com

CTS
CUTTING TOOL SALES, LLC

36430 Reading Ave. Willoughby, OH 44094

440.946.2066

sales@cuttingtoolsales.com

High Productivity Drilling

Exchangeable drilling heads for DCN drills,
for machining ISO P materials.
The drill head is designed with a honed cutting
edge, available in increments of 0.1 mm.



1

Use Promo Code: **T2410**

Purchase

6 ICP/HCP/FCP/ICM/QCP/ICN/IFP/ICG/ICK/ICP/IHP...
assorted exchangeable heads from Dia 0.157" ~1.295"

Receive 50%

Additional Discount

on the corresponding DCN/DCNS/DCNT... drill body (up to 8xD)



High Productivity Beam Drilling

Newly designed exchangeable drill heads for beam drilling (-BD) feature a dedicated self-centering cutting edge which guarantees accurate hole penetration, while its sharp corners effectively prevent the formation of burrs. Together with a reinforced drill body, it provides an **effective solution for drilling relatively thin workpieces under unstable conditions.**

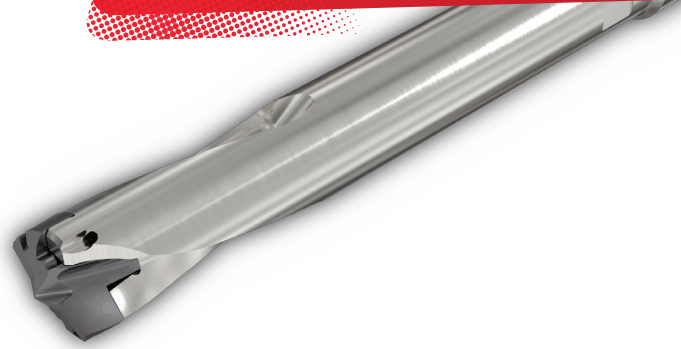

1

Use Promo Code: **T2404**

Purchase

6 IHP/IFHP-...BD assorted inserts from dia 0.543"~1.5625"

Receive

Corresponding SUMOCHAM DCN-...BD or CHAM-SPADE-IQ DFN-...BD drill body (up to 8xD)

Free of Charge

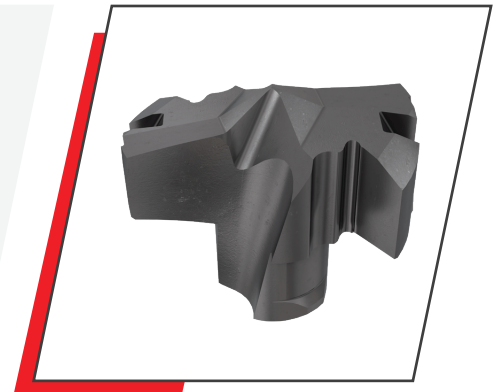

High Feed Parting Tools Vibration Free



Revolutionary quad blade and unique holder enable deeper parting with high feed rates. Guarantees no vibration, excellent part straightness, improved surface finish, and material savings. A 6.3" (160mm) bar diameter can be parted with a .118" (3mm) insert.



1

Use Promo Code: **T2412**

Purchase

20 TAG inserts from width 2-5 mm
same size any assortment

Receive

Corresponding TGAQ / TGAQ-JHP / TGAQ-ECD blade

Free of Charge

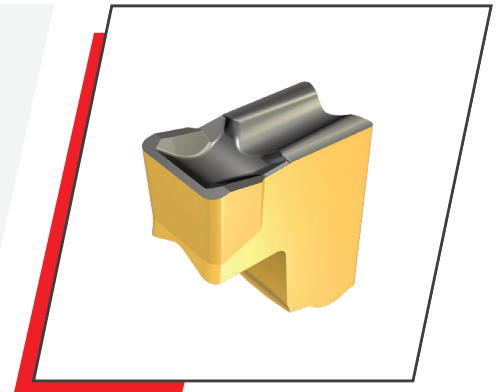

2

Use Promo Code: **T2413**

Purchase

20 TAG inserts from width 2-5 mm
+ corresponding TGAQ / TGAQ-JHP / TGAQ-ECD blade

Receive

Corresponding TGTBQ block

Free of Charge

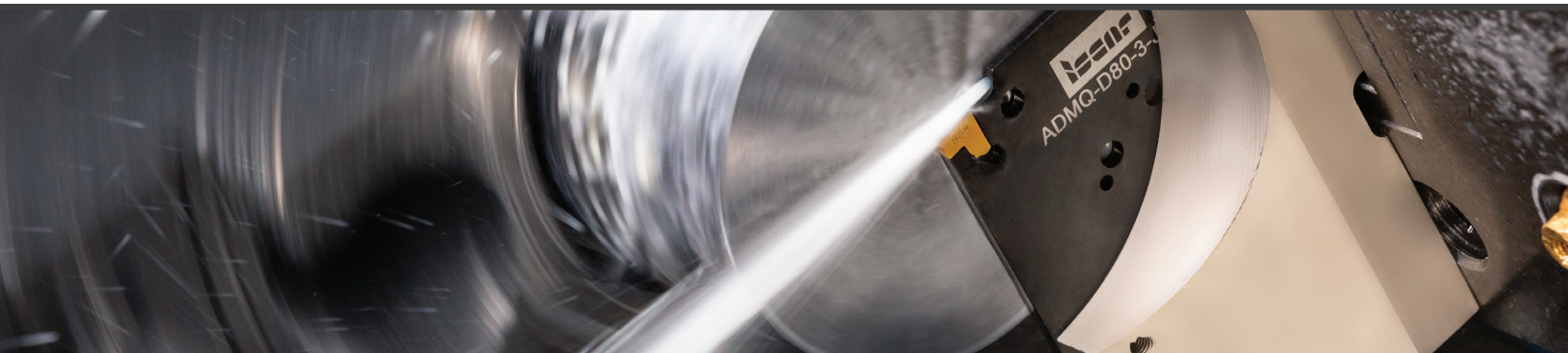
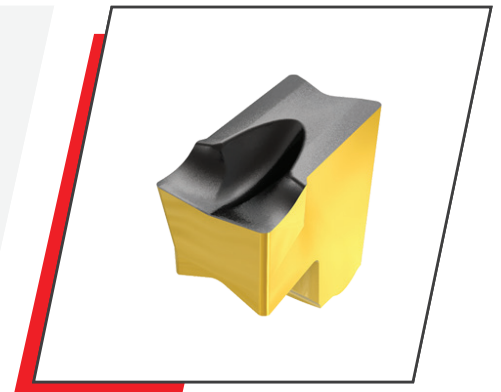

High Feed Parting Tools Vibrations Free

Revolutionary quad blade and unique holder enables deeper parting with high feed rates. Guarantees no vibration, excellent part straightness, and improved surface finish.



1

Use Promo Code: **T2415**

Purchase

20 DGN/R/L inserts from width 2-5 mm same size any assortment

Receive

Corresponding DGAQ / DGAQ-JHP blade

Free of Charge

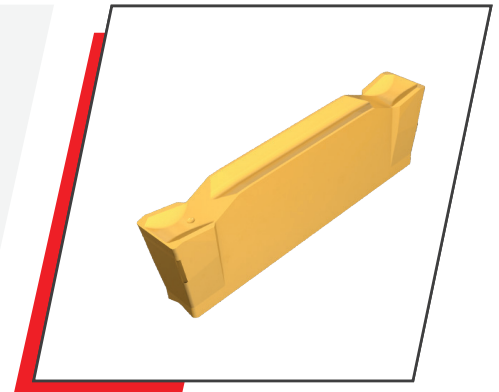

2

Use Promo Code: **T2416**

Purchase

20 DGN/R/L inserts from width 2-5 mm + corresponding DGAQ / DGAQ-JHP blade

Receive

Corresponding TGTBQ block

Free of Charge

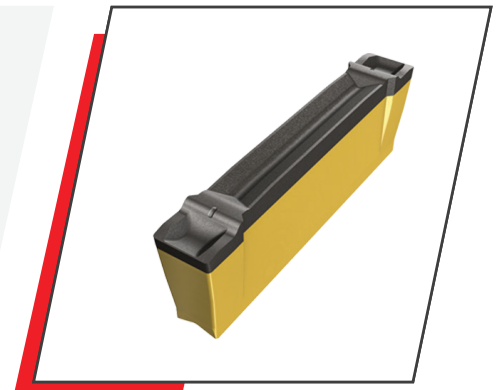

Double-Sided Insert with 4 Positive Cutting Edges

ISCAR offers new double-sided inserts with 4 unique cutting edges as an advantageous alternative to the conventional ISO standard positive inserts with 2 cutting edges.



1 Use Promo Code: **T2417**

Purchase

20 CXMG 09 assorted inserts

Receive

Corresponding **external** holder PCLXL/R..3X

at 75% Additional Discount Or

Corresponding **internal** holder A... PCLXL/R..3X

at 50% Additional Discount

* JHP and AVC holders are not included

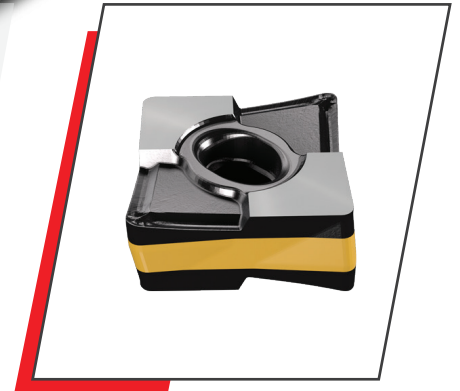

2 Use Promo Code: **T2418**

Purchase

20 CXMG 12 assorted inserts

Receive

Corresponding **external** holder PCLXL/R..4X

at 75% Additional Discount Or

Corresponding **internal** holder A... PCLXL/R..4X

at 50% Additional Discount

* JHP and AVC holders are not included

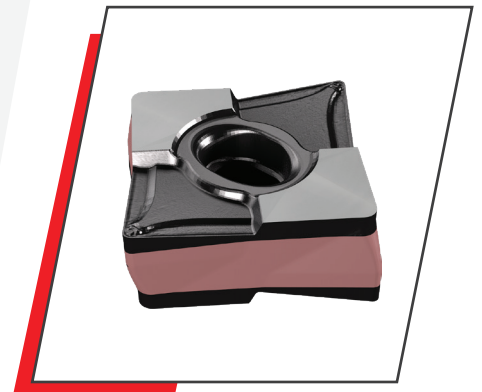

MULTIFUNCTION LINE OF INSERTS and Toolholders for External Turning, Face Turning and Profiling Operations.

NEOTURN inserts feature a unique angle of 70° which provides extra clearance compared to conventional CNMG 80° inserts with additional strong points compared to DNMG 55° inserts.

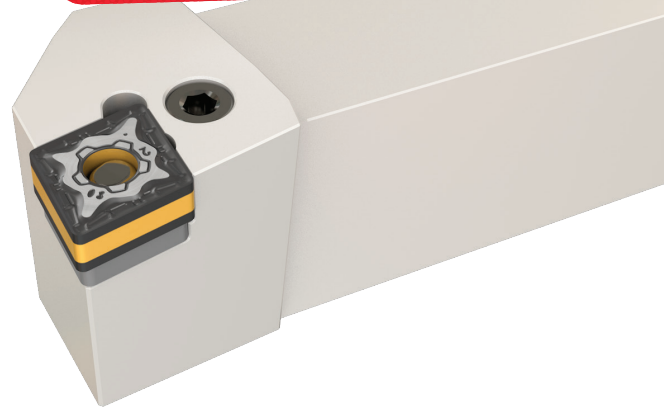

1

Use Promo Code: **T2419**

Purchase

20 XNMG 33 assorted inserts

Receive

Corresponding holder DXJNR/L..3-..

at 50% Additional Discount

* AVC holders are not included

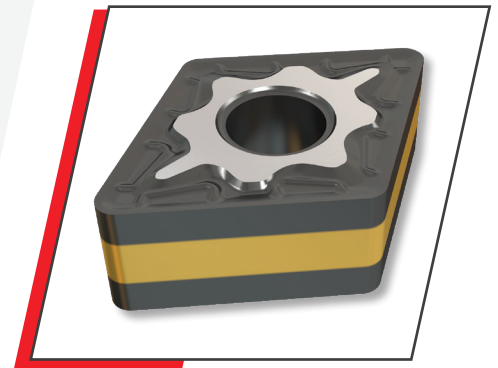

2

Use Promo Code: **T2420**

Purchase

20 XNMG 43 assorted inserts

Receive

Corresponding holder DXJNR/L..4-..

at 50% Additional Discount

* AVC holders are not included

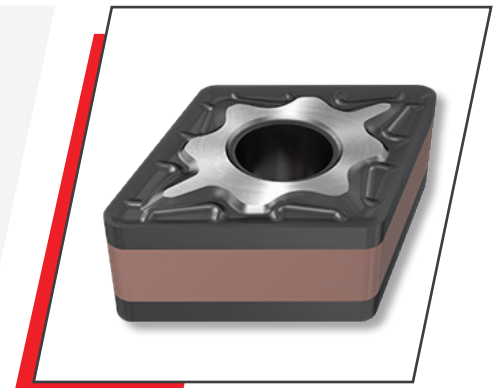

Solution for External and Internal Threading

The **ISCAR** threading family includes 5 types of tools for the production of external threading and 4 types of tools for the production of internal threading.

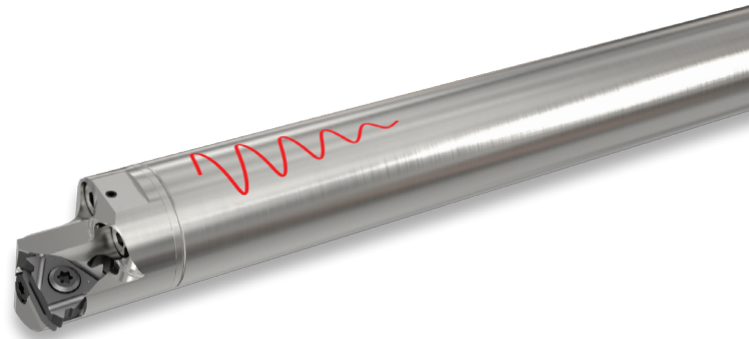

1 Use Promo Code: **T2421**

Purchase

10 threading LD ER/EL/IR/IL/ERB/ERM 08/11/16/22 assorted inserts

Receive 25% Additional Discount

* All profiles

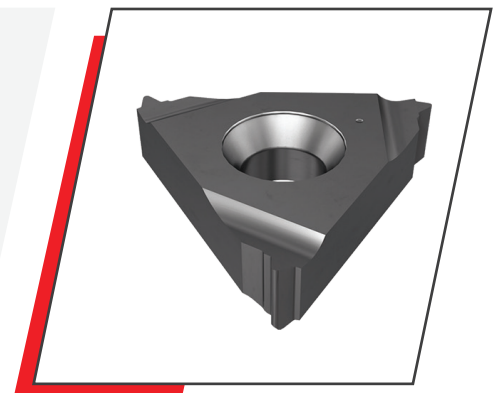

Or

2 Use Promo Code: **T2422**

Purchase

20 threading LD ER/EL/IR/IL/ERB/ERM 08/11/16/22 assorted inserts

Receive 30% Additional Discount

* All profiles

